

MREM 80 AgorGR

APS mini Plus reader modules for A-Bell and IP Bell entry panels

User's guide



techfass®

1 Content

1	Content.....	2
2	Product Description	3
3	Technical parameters	3
3.1	Product version.....	3
3.2	Technical features.....	4
3.3	Mechanical design	4
4	Installation	5
4.1	Reader module description	5
4.2	C1 and C2 cable wiring description	5
4.3	Reader module standard connection.....	6
4.4	Inputs and outputs general connection.....	7
4.5	D1 LED Indication	7
4.6	Installation instructions.....	7
4.7	Mounting and removal the MREM 80 AgorGR module.....	8
5	Setting parameters of the reader module.....	9
5.1	Configurable parameters.....	9
5.2	Reader module parameters setting	9
6	Reader module functioning	10
6.1	“Door Open” function description	10
6.2	Function permanent door lock release according to a time schedule	10
6.3	Alarm states.....	11
6.4	Standard operating modes.....	12
6.5	Read ID media format	12
6.6	Programming mode	12
6.7	ID expiration function	16
6.8	ID with Alarm flag function	16
6.9	Antipassback function	16
6.10	Disabling function.....	18
6.11	Online authorization	18
7	Simplified access rights evaluation	18
8	Useful links	19

2 Product Description

The *MREM 80 AgorGR*¹⁾ reader modules (125 kHz readers with an embedded single door controller) are designed for connection to the RS 485 bus of the *APS mini Plus* access control system. It is possible to connect up to 32 reader modules to a single line of the APS mini Plus system. In effect the number of lines is not limited.

The module is designed for installation in *A-Bell* and *IP Bell* entry panels of *ALPHATECH TECHNOLOGIES s.r.o.* audio and video systems (design as *Agora* entry panels of *ACI Farfisa* company), where it occupies space of a single push button. The module comes in *GR* (anthracite grey) color version of the plug.

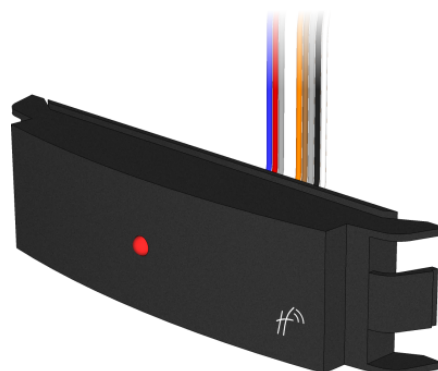

Pic. 1: MREM 80 AgorGR

¹⁾ Commercial designation of available versions is described in *table 1*.

3 Technical parameters

3.1 Product version

Product version	Product designation	Catalogue number	Module features ²⁾		
			TF	EM	HID
	MREM 80 AgorGR – TF	53480A00	✓	✗	✓
	MREM 80 AgorGR – EM	53480A01	✓	✓	✓

Table 1: Product version

²⁾ *TF* – TECHFASS factory ID media reading; *EM* – EM Marin ID media reading; *HID* – HID Proximity ID media reading

3.2 Technical features

Technical features	Supply voltage	8 ÷ 28 VDC	
	Current demand	Typical	60 mA
		Maximal	90 mA (8 V)
	Version with keypad	N/A	
	ID technology, typical reading range	EM Marin	5 cm (with ISO card)
		HID Proximity	4 cm (with ISO card)
	Real-time clock	Yes	
	Memory	Cards	2,000 ID, 2 programming cards
		Events	3,400
		Time schedules	64
	Inputs	1 st input	Logical potential-free contact
		2 nd input	Logical potential-free contact
	Output	Door lock ³⁾	1x open collector 0V active, max. 2A, 24V
		Alarm	N/A
	Signalization	1x LED 1x PIEZO	
Tamper protection	N/A		
Communication interface	RS 485		
Alternative data input / output	N/A		

Table 2: Technical features

³⁾ The DC type of door lock has to be used only! Suitable anti-parallel diode has to be connected to its coil as over-voltage protection.

3.3 Mechanical design

Mechanical design	Weight	0.023 kg
	Operating temperature	-25 ÷ 60 °C
	Humidity	Max. 95%, non-condensing
	Housing	IP 54 (built in the entry panel)
	Pigtail	2x 0.4 m
	Color	Anthracite grey
	Dimensions (Height x Width x Depth)	21x84x15 mm

Table 3: Mechanical design

4 Installation

4.1 Reader module description

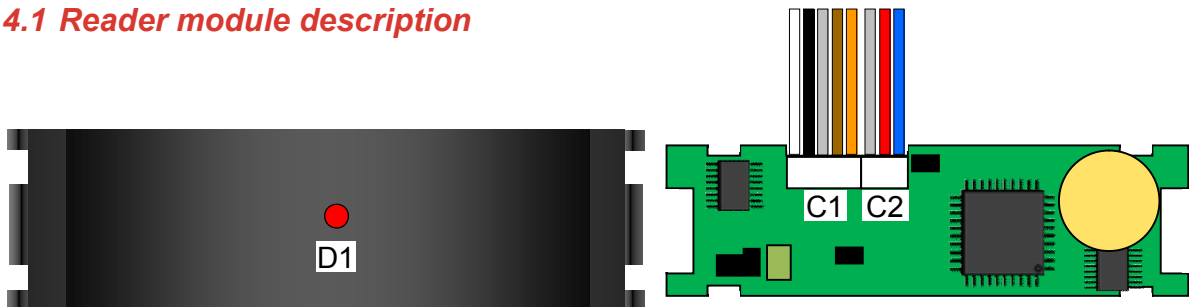

Pic. 2: MREM 80 AgorGR reader module, front (left) and rear (right) view

Description	Designation	Purpose
	C1	Connector for C1 cable (5-wires) connection
	C2	Connector for C2 cable (3-wires) connection
	D1	Red-green LED indicator

Table 4: Connectors, jumpers and LED indicators description

4.2 C1 and C2 cable wiring description

Wiring description	C1 cable		C2 cable	
	Color	Function	Color	Function
	White	B wire - RS485 line	Grey	0 V (GND)
	Black	A wire - RS485 line	Red	Power supply +8 ÷ +28VDC
	Grey	0 V (GND)	Blue	Output 1 - OC
	Brown	Input 1 (IN1)		
	Orange	Input 2 (IN2)		

Table 5: C1 cable wiring description

All unused wires must be mutually isolated!

4.3 Reader module standard connection

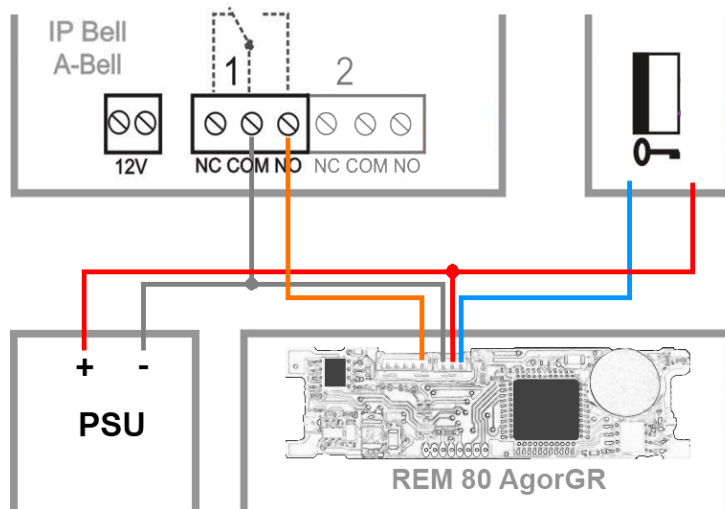

Pic. 3: Standard reader module connection with use DC power supply and the relay contact of the A-Bell / IP Bell entry panel

Standard connection	Signal	Connection
	+ 8 ÷ + 28 VDC	+ contact (power supplier unit), red wire of C2 cable (reader module), + contact (door lock)
	0 V (GND)	- contact (power supplier unit), grey wire of C2 cable (reader module), COM contact of relay 1 (entry panel)
	Release lock from panel	NO contact of relay 1 (entry panel), orange wire of C1 cable (reader module)
Release lock from reader	Blue wire of C2 cable (reader module), - contact (door lock)	

Table 6: Reader module connection using entry panel relay as a signal for door lock release

This connection requires configuring the function of the second input of the reader module as **Request to exit button** (default module setting, see pic. 4). Used entry panel relay must be configured for door lock release function; the relay activation is a signal for the reader module (orange wire) to release the door lock then. The door lock release is controlled by the output of the reader module (open collector, 0 V (GND) active – blue wire).

Pic. 4: Reader module setting

The reader module is powered by a **DC** power supplier. When using suitable power supplier and door lock type, you can power all components (entry panel, reader module and door lock) from a single power supplier. If an **AC** powered door lock must be used, it is necessary to use an individual **external relay** controlled by the OC signal from the reader module to control the door lock.

4.4 Inputs and outputs general connection

IO ports	Input 1	Door contact, active when door closed; REX button
	Input 2	Request to exit button or handle contact, active when button or handle pressed; Tamper; Disabling function
	Output 1	Door lock control open collector, 0V active (also configurable for reverse locks)

Table 7: Inputs and outputs general connection

The door monitoring contact (IN1) is operational after its first change of status since switching on the module. Full door lock timing acc. to *tab. 9* is used when the door status contact is not installed and no Forced Door and Door Ajar alarms are triggered.

4.5 D1 LED Indication

LED indicators	Red	Continuously lit	Online operating mode via RS 485
		Flashing with 4 s period	Offline operating mode
	Green	ID media reading	
	Red/Green switching	Address setting mode, RS 485 bus testing	
	Yellow	Continuously lit / flashing	Programming mode
		Short flashing with 1s per.	Indicating door lock release

Table 8: LED indication

4.6 Installation instructions

The reader module uses passive RF/ID technology, which is sensitive to RF noise sources. Noise sources are generally of two types: radiating or conducting.

Conducted noise enters the reader via wires from the power supply or the host. Sometimes, switching power supplies generate enough noise to cause reader malfunction, it is recommended to use linear system power supplies.

Radiated noise is transmitted through the air. It can be caused by computer monitors or other electrical equipment generating electromagnetic fields.

Consequently, a short distance between the reader modules themselves can cause reading malfunctions – for correct operation it is necessary to keep a minimum distance of 50 cm. Various metallic constructions may have a negative influence on this distance; if there are any doubts, it is recommended to perform a practical test before final mounting.

Nearby metal surfaces may cause a decrease in reading distance and speed. This is caused by the combined effects of parasitic capacitance and conductance.

4.7 Mounting and removal the MREM 80 AgorGR module

4.7.1 Module mounting

When mounting the module in the entry panel it is necessary to *unscrew the screw* located in the front part of the panel (*pic. 5a*) and open the front cover. The reader module can be placed *instead of the last but one button* in the front part of the panel from top. First it is necessary to *remove the lowest button* (*pic. 5b*). Continue by *removing the second button* (*pic. 5c*). Insert the reader module in the *prepared slot* (*pic. 5d*) and press the module until you *hear the click of the latch* holding the reader in position (*pic. 5e*). Insert the button back to the lowest position with the same procedure as the one used for inserting the reader module. Lead the *C1* and *C2* cables from behind into the back part of the panel through the *perforated membrane* (*pic. 5f*). Connect the *C1* and *C2* cables in the reader module. The last step is completing the entire panel again. Slide the front part into the back part (*pic. 5g*) and screw the securing screw (*pic. 5h*).

4.7.2 Module removal

When disassembling the module use a similar procedure as described in the previous chapter, just remember to *unplug the panel and the reader module from the power supply first!*

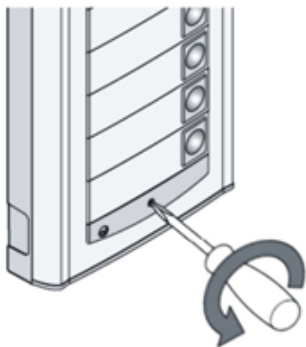

Pic. 5a

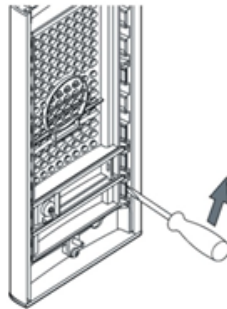

Pic. 5b



Pic. 5c

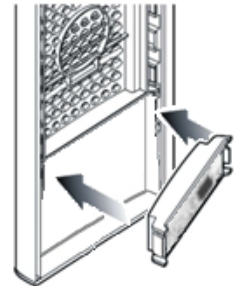

Pic. 5d

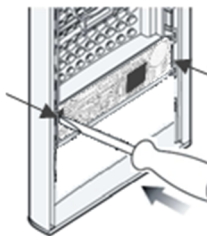

Pic. 5e

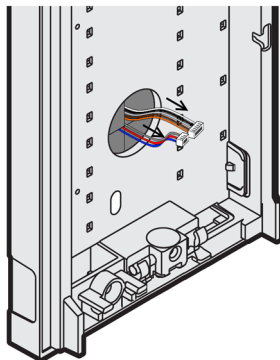

Pic. 5f



Pic. 5g

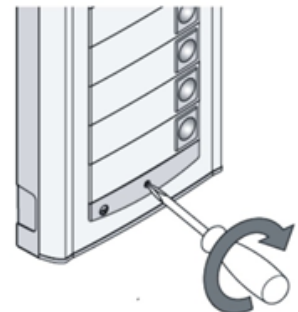

Pic. 5h

5 Setting parameters of the reader module

5.1 Configurable parameters

Configurable parameters	Parameter	Possible range	Default setting
	Door lock release time	0 ÷ 255 s	7 s
	Door lock control setting	Direct / reverse	Direct
	Door lock relay function setting	Standard / toggle / pulse	Standard
	Permanent door lock release according to a time schedule	Never / Schedule index	Never
	Door lock status indication	YES / NO	NO
	Acoustic signal of door lock release	YES / NO	YES
	Door ajar time	0 ÷ 255 s	20 s
	First input configuration	Door contact / REX button	Door contact
	Second input configuration	REX button / handle contact / external tamper / disabling function	REX button
	Acoustic signalization time - Tamper	0 ÷ 255 s	30 s
	Acoustic signalization time - Forced door	0 ÷ 255 s	30 s
	Acoustic signalization time – Door ajar	0 ÷ 255 s	0 s
	Acoustic signalization time – APB alarm	0 ÷ 255 s	0 s
	Signalization time – Card alarm	0 ÷ 255 s	30 s
	Antipassback function setting	See <i>chapter 6.9</i>	Disabled
	Automatic summer time adjustment	YES / NO	YES
	Release lock with REX button when tamper alarm active	YES / NO	YES
	Online authorization timeout	0 ÷ 25500 ms	800 ms
	Standalone authorization after timeout	YES / NO	YES
Saving events in the module's archive	Door opened	Enabled / Disabled	Enabled
	Door closed	Enabled / Disabled	Enabled
	Input 2 On	Enabled / Disabled	Enabled
	Input 2 Off	Enabled / Disabled	Enabled
	Strike released	Enabled / Disabled	Enabled
	Strike closed	Enabled / Disabled	Enabled

Table 9: Configurable parameters

5.2 Reader module parameters setting

Detailed instructions for setting reader module parameters are described in the *APS mini Plus.Reader* configuration program user's guide available at the address http://www.techfass.cz/files/m_aps_miniplus_reader_en.pdf.

6 Reader module functioning

The reader module supports the following functions:

- Standard “Door Open” function.
- Door status monitoring.
- Exit-devices contact monitoring.

The “Door Open” function can be activated in 3 different ways:

- Reading a valid ID (card, key fob...).
- Pressing the exit button (according to configuration) – cannot be used in alarm condition.
- Via communication line (program request).

6.1 “Door Open” function description

In case the *standard function of the door lock relay* is set, the door lock is *released* and the *beeper activated* (when not disabled) when the “Door Open” function is activated. Both outputs stay active until the door is opened or the preset door lock release time has elapsed - see *configuration table*.

In case the *toggle function of the door lock relay* is set, the door lock relay status is *switched* and the *beeper is activated* (when not disabled) when the “Door Open” function is activated. The beeper stays active until the door is opened or the preset door lock release time has elapsed - see *configuration table*. The door lock relay status remains unchanged until another “Door Open” function is activated.

In case the *pulse function of the door lock relay* is set, the door lock relay status is switched for the time defined by the *Pulse width* parameter (*ms*) after the Door Open function is activated.

In case the standard function of the door lock relay is set, reading a valid card during door lock release resets the door lock release time.

6.2 Function permanent door lock release according to a time schedule

When the function is set, the door lock is permanently released when relevant time schedule is valid. Reading a valid ID is standardly announced via the communication line (in online operating mode). The forced door alarm cannot be raised when the door lock is permanently released.

The permanent door lock release function and the toggle function of the door lock relay are mutually exclusive.

6.3 Alarm states

The reader module can get in following alarm states:

- 1) Tamper alarm
- 2) Forced door alarm
- 3) Door ajar alarm
- 4) Antipassback alarm (Time APB alarm, Zone APB alarm)
- 5) ID with Alarm flag alarm

Alarm state reporting is performed as follows:

- Via communication line (statuses 1, 2, 3, 4, 5)
- By acoustic signal (beeper) (statuses 1, 2, 3, 4).

Alarm signaling via communication line requires online running PC with relevant software suitable for online operation (APS Administrator).

Two ways of acoustic signaling is carried out:

- Steady signal (tamper).
- Intermittent signal (forced door and/or door ajar, APB alarm).

Acoustic alarm signaling is stopped after a valid ID is presented or pre-set time interval is elapsed, see the configuration table.

6.3.1 Tamper alarm

In case of tampering the module (by changing the status of input 2 or input 3 in proper configuration) the “Tamper” state is activated³⁾.

³⁾ The Tamper alarm handling is operational after their first change of status since switching on the module. There is no need to configure the module when the tamper protection is not used.

6.3.2 Forced Door alarm

The “Forced Door” alarm state is activated when the door is opened without activating the “Door Open” function. The only exception is opening the door with the second module input IN2 active and configured as a handle contact.

6.3.3 Door Ajar alarm

If the door stays open until the pre-defined Door ajar timeout expires – see *Tab. 12*, the “Door Ajar” alarm is activated.

6.3.4 Antipassback alarm

The *Antipassback alarm* is raised when an ID is read during the *Time APB* counter is running or when the ID is blocked by a *Zone APB*.

6.3.5 ID with Alarm flag alarm

ID with Alarm flag alarm occurs when an ID with the Alarm flag is read.

6.3.6 Reading ID during alarm state

Reading an ID doesn't affect the alarm state, reading a valid ID only terminates the acoustic alarm announcement followed by "Door Open" function. Reading an invalid ID only interrupts the acoustic announcement of the alarm state while signaling "Invalid ID".

6.4 Standard operating modes

The reader module can be in either *online* or *offline* operating mode. The module's functionality is identical in both operating modes; the events archive is read from the reader module's memory when the module goes online. When a programming card is read (while in either online or offline mode), the module goes into programming mode.

6.5 Read ID media format

6.5.1 EM Marin ID media format

The EM Marin ID media format can be changed into selected 24, 32 or 40 bits length of ID code. The default length is 40 bits. This setting is only used when unifying of the ID media codes length is required – in combined systems with WIEGAND output readers with a fixed WIEGAND data format IDs (more information in *APS Reader* user's guide available at http://www.techfass.cz/files/m_aps_miniplus_reader_en.pdf).

6.5.2 HID Proximity ID media format

When working with *HID Proximity* technology ID media, the module operates with a code in a recognized 26 or 32 bit format, in other cases it uses all 45 bits of a media (45bit raw format). If a specific format of the *HID Proximity* IDs is required, it can be performed by setting up the user's configuration of read IDs (more information in *APS Reader* user's guide available at http://www.techfass.cz/files/m_aps_miniplus_reader_en.pdf).

6.6 Programming mode

The module enters programming mode by reading one of the two *programming cards* (cards "+" and "-"). The programming mode cannot be entered while the module is in hardware address setting mode (for modules with HW address setting via the communication line). The module's functionality in programming mode can be seen in *pictures 6 a-d*.

It is not possible to use time schedules when inserting cards in programming mode, therefore cards are always valid.
--

6.6.1 Inserting cards into the reader's memory

Follow these steps for inserting cards into the reader module's memory:

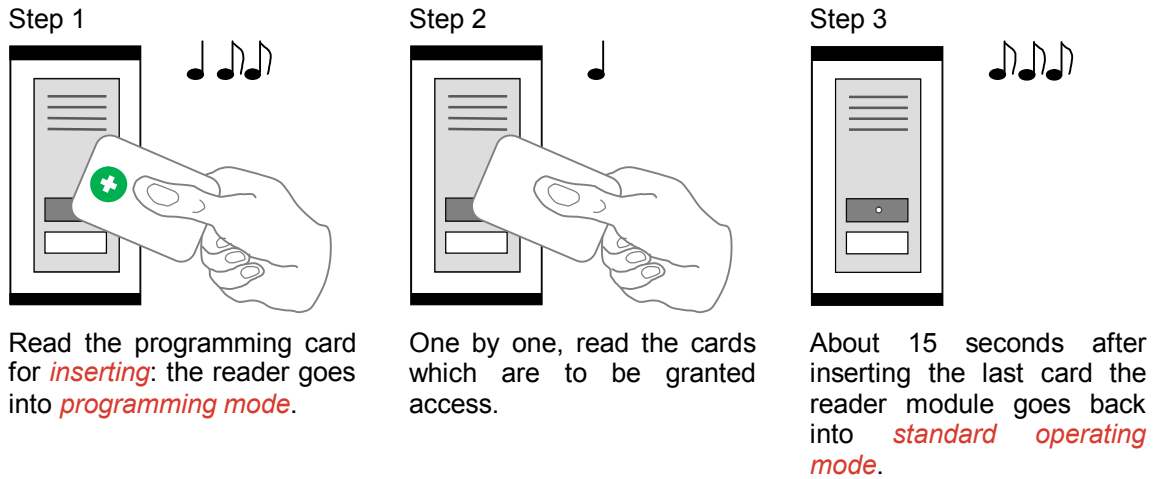

Pic.6 a): Inserting cards

6.6.2 Deleting cards from the reader's memory

For deleting the cards from the reader module's memory use following steps:

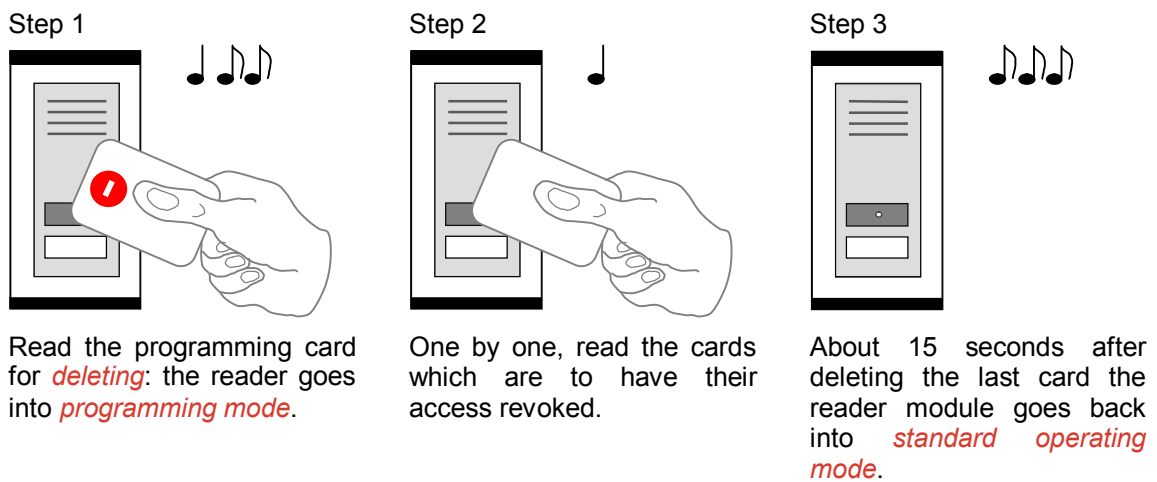

Pic.6 b): Deleting cards

6.6.3 Deleting cards „above or below“

If a user loses his ID medium, it is usually impossible to delete the ID from the memory with the procedure described in the previous chapter, since the medium is no longer available (with an exception of entering the code at the keypad). Following procedure can be used for deleting such ID. The procedure *requires using an ID medium*, which was inserted *right before or right after the ID medium*, which should be deleted.

Step 1

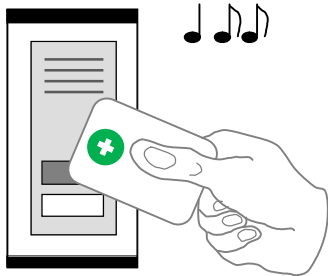

Read the programming card for *inserting*: the reader goes into *programming mode*, which is indicated by slow flashing of yellow LED.

Step 2



Read the programming card for inserting 5 times in a row; the reader will go into *Deleting cards "above or below"* mode indicated by fast flashing of yellow LED.

Step 3

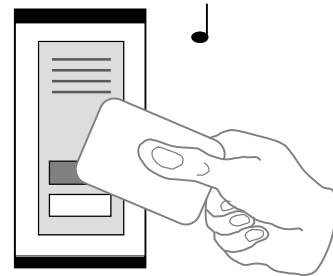

Read a card, which is located in the module's memory *right before or right after* the card you wish to delete. After this step the module quickly flashes with yellow LED.

Step 4 - A

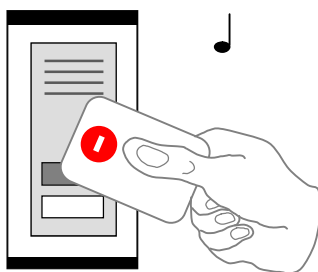

For deleting an ID located *right before* the ID used in previous step, read the programming card for *deleting*.

Step 4 - B

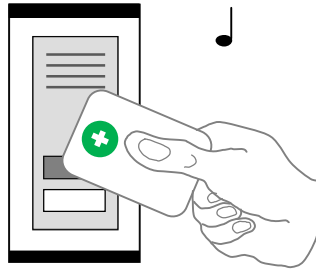

For deleting an ID located *right after* the ID used in previous step, read the programming card for *inserting*.

Step 5

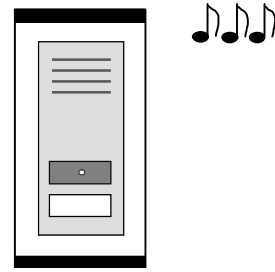

The reader module goes back into *standard operating mode*.

Pic.6 c): Deleting cards "above or below"

6.6.4 Deleting all cards from the reader's memory

Follow these steps for deleting all cards from the reader module's memory:

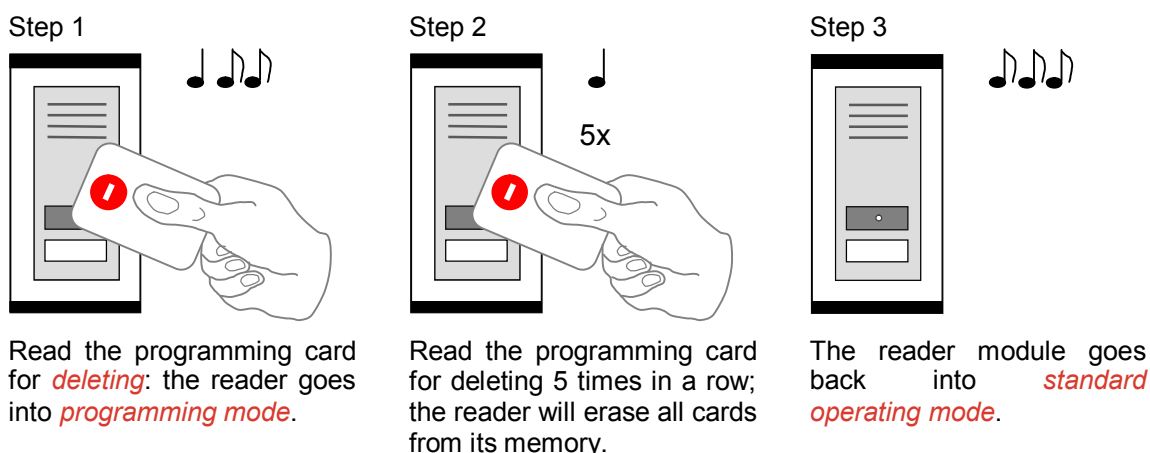

Pic.6 d): Deleting all cards

6.6.5 Recommended method for access rights management (using prog. cards)

In case of managing access rights of plenty of users (using programming cards only), it is appropriate to establish a table, which summarizes operation with the reader module memory. All operations (adding and deleting cards) should be stored in the table. Following example shows correct usage of the programming cards and proper filing of the actions:

- Inserting **5 new cards** using the procedure from chapter 6.7.1 – Read + **(inserting) programming card**, read **cards 1-5**, after 15 s the programming mode is exited, **create a table**.

position	card
1	card 1
2	card 2
3	card 3
4	card 4
5	card 5

Pic.6 e): Table after inserting 5 cards

- Card 3 gets lost** – Delete it **using the card 4**, which is available, and using the procedure from chapter 6.6.3 – Read + **(inserting) programming card**, then **5x + (inserting) programming card** again, then **card 4**, and finally – **(deleting) programming card**. Register the change in your table.

position	card
1	card 1
2	card 2
3	card 3 (lost)
4	card 4 (available)
5	card 5

→

position	card
1	card 1
2	card 2
3	card 3
4	card 4
5	card 5

Pic.6 f): Deleting card 3 using the card 4, table after deleting card 3

- **Card 4 gets lost** – Delete it *using the card 2*, which is available, and using the procedure from *chapter 6.6.3 – Read + (inserting) programming card*, then *5x + (inserting) programming card* again, then *card 2*, and finally *+ (inserting) programming card* again. *Register the change in your table.*

position	card
1	card 1
2	card 2 (available)
3	card 3
4	card 4 (lost)
5	card 5

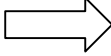

position	card
1	card 1
2	card 2
3	card 3
4	card 4
5	card 5

Pic.6 g): Deleting card 4 using the card 2, table after deleting card 4

- It is necessary to *add another card* (card 6). We proceed with the procedure from *chapter 6.7.1* again. *1 – Read + (inserting) programming card*, read *cards 1-5*, after 15 s the programming mode is exited. *Register the change in your table.*

position	card
1	card 1
2	card 2
3	card 3
4	card 4
5	card 5
6	card 6

Pic.6 h): Table after inserting card 6

A new card is always inserted at the position after the last inserted card. In case of deleting all cards using the procedure described in *chapter 6.6.4*, it is necessary to create a new filing table.

6.7 ID expiration function

This function is implemented since the FW version 5.0.

It is possible to set an *Expiration date* for every *ID* stored in the module. When the date occurs, the ID becomes invalid (expired). The expiration evaluation is performed on every date change in the module's RTC and when the access rights are downloaded.

6.8 ID with Alarm flag function

This function is implemented since the FW version 5.0.

It is possible so set an *Alarm – ID flag* for every *ID* stored in the module. When the ID is read, relevant alarm is raised (and the alarm output is switched for preset time).

6.9 Antipassback function

This function is implemented since the FW version 5.0.

The Antipassback function is defined in two ways:

- *Time APB* – user cannot repeatedly use his ID for defined time
- *Zone APB* – user cannot repeatedly enter an area, where he is already present

The Antipassback function is used *only for the users*, whose access is driven by a *time schedule*. The users with access always granted are not affected by the Antipassback function.

The Antipassback flags for an *ID* can be *reset* by *inserting the ID again* with use of the *programming cards* (offline solution). *All Antipassback flags* are also *reset* whenever new *access rights data are downloaded* from the program.

Both Zone and Time Antipassback flags are written either immediately *after an ID is read*, or after relevant *door is opened* (relevant input is disconnected).

6.9.1 Time Antipassback

The *Time Antipassback* is defined by the *ABP timer initial value* (in minutes), which is set to the ID after passing at the reader module. If the users uses the ID at the address during the timer for the ID is running, the Time APB alarm is raised. Following parameters affect the Time APB function:

- *APB timer initial value* – defines the Time APB flag (timer) value set to the ID after passing at the reader module. If a user uses the ID again before the timer elapses, Time APB alarm is raised.
- *Open door after APB time alarm* – if the option is enabled, the Door open function is performed after the Time APB alarm is raised.

6.9.2 Zone Antipassback

The *Zone Antipassback* is defined by *enabling the option* for the relevant address. The Zone APB flag is set for the ID when passing at the reader module. If a user uses the ID again when the Zone APB flag is set, the Zone APB alarm is raised. Following parameters affect the Zone APB function:

- *Enabled* – enable/disable general Zone APB flag setting.
- *Enable in offline mode* – if the option is not set, the module operates in offline mode like if the APB function was not implemented.
- *Open door after APB Zone alarm* – if the option is enabled, the Door open function is performed after the Zone APB alarm is raised.

6.10 Disabling function

This function is implemented since the *FW version 5.08*.

The *module disabling function* can be set as the second input function. The logic of the function is configurable.

The module behaves as described below when the disabling function is active:

- User with access driven by a time schedule cannot run the door open function
- User with access always granted is not affected by the disabling function
- Remote door open function cannot be performed
- Remote identification with ID is disabled for users with access driven by a time schedule

The disabling status changes and disabled actions are logged in the events archive.

6.11 Online authorization

Since the *FW version 5.11* the *Online authorization of ID* can be used in APS mini Plus system. When the feature is used, the ID validity is resolved in connected PC. To be able to use this authorization mode, the reader module has to be equipped with a *MLO* license.

7 Simplified access rights evaluation

The model of access rights contains time schedules and a table of holidays. A block diagram for access right evaluation can be seen in *Pic.7*.

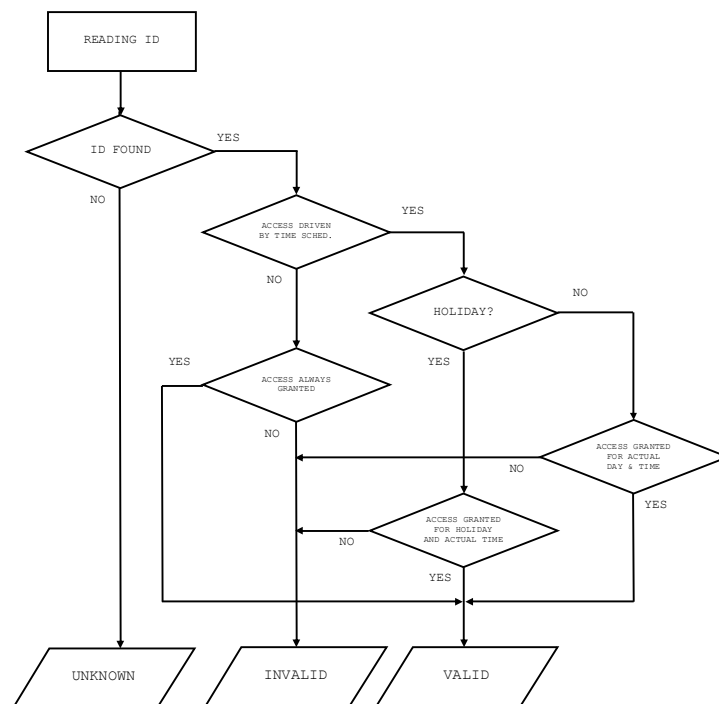

Pic. 7: Simplified access rights evaluation

8 Useful links

- Wiring diagrams: <http://techfass.cz/diagrams-aps-mini-plus-en.html>
- Program equipment: <http://techfass.cz/software-and-documentation-en.html>